

ELM-12-4.0-9-C



Lens module specifications

Effective focal length	12	mm	
F/#	4.0	fixed	
Maximum sensor format	1/1.8"	inch	
Maximum image circle (Φ)	9	mm	
Lifecycles (10-90% sinusoidal)	>1'000'000'000	cycles	
FOV	Diagonal (9mm)	41.1	°
	Horizontal (7.2mm)	33.4	°
	Vertical (5.4mm)	25.4	°
Back Focal Length	13.2	mm	In air
Optical Distortion	<0.13	%	
Pixel size recommended	3.45	µm	
Wavelength range	435 to 656	nm	Different coatings available upon request
Relative illumination	>80	%	
Max chief ray angle	<5	°	
Working distance range	100 to infinity	mm	
Mount	C-mount		
Total Track Length	55.6	mm	In air
Dimension (L × W × H)	38.09 × 29.00 × 44.80	mm	

Focus tunable lens specifications

EL-3-10-VIS-26D

Focal power range (@20°C)	-13 to +13	dpt	
Wavefront error @525nm (vertical/horizontal optical axis)	<0.2/<0.2	λRMS	
Operating temperature	-20 to +65	°C	
Storage temperature	-40 to +85	°C	
Temperature compensation	No		

Electrical specifications

Control current (typical)	-120 to +120	mA	
Operating voltage	-1...1	V	
Power consumption (full tuning range)	0 to 100	mW	$P = R_{Coil} \times I^2$
Power consumption (+/- 5 dpt tuning range)	0 to 15	mW	
Settling time	2 to 4	ms	Low pass filtered / normal step signal

Hirose connector (HR10G-7R-6P)

	Function
Pin 1	Control current +
Pin 2	Control current -
Pin 3	Not connected
Pin 4	Not connected
Pin 5	Not connected
Pin 6	Not connected

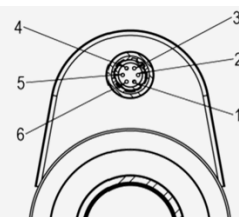

Controller

The liquid lens is controlled with electrical current and must be operated by a suitable lens controller. Hirose cables and liquid lens controllers are sold separately. The following controllers are considered fully compatible:

- Optotune lens driver EL-E-4i
- Optotune industrial controller ICC-4C-500
- OPT-LLC0524E-4



Additional selection of controllers is available at www.optotune.com/controllers

Mechanical drawings

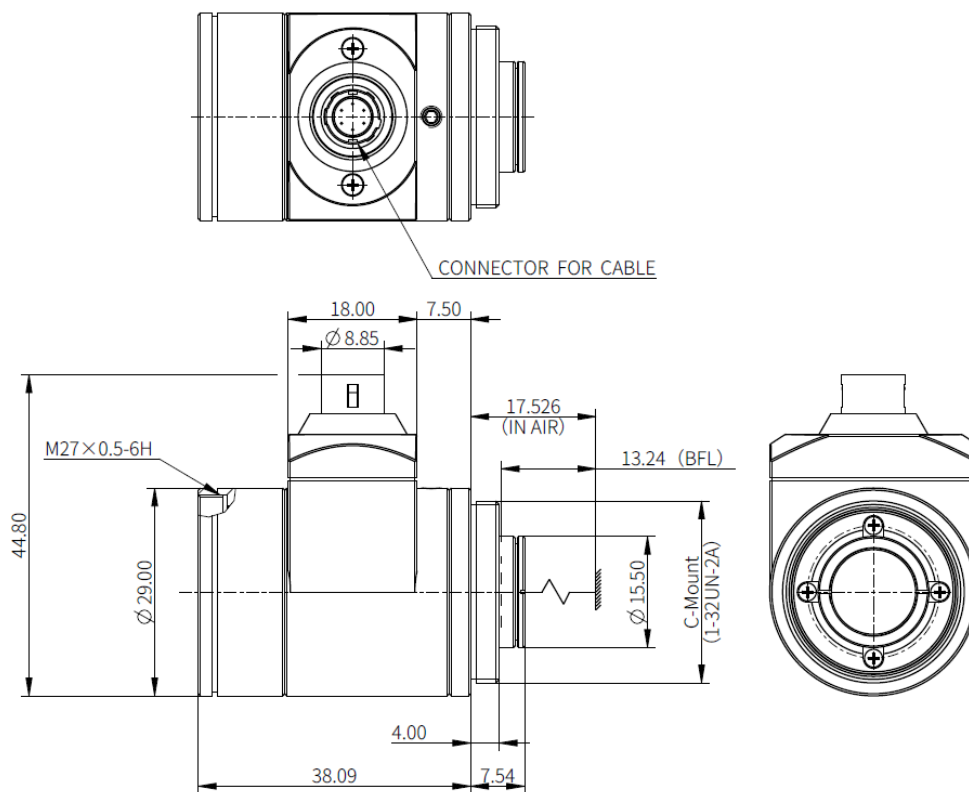

Figure 1: Mechanical drawing of the ELM-12-4.0-9-C

For more information on optical, mechanical and electrical parameters, please contact sales@optotune.com.